

WORKING COW HORSE PATTERN 12

Thursday
All Classes

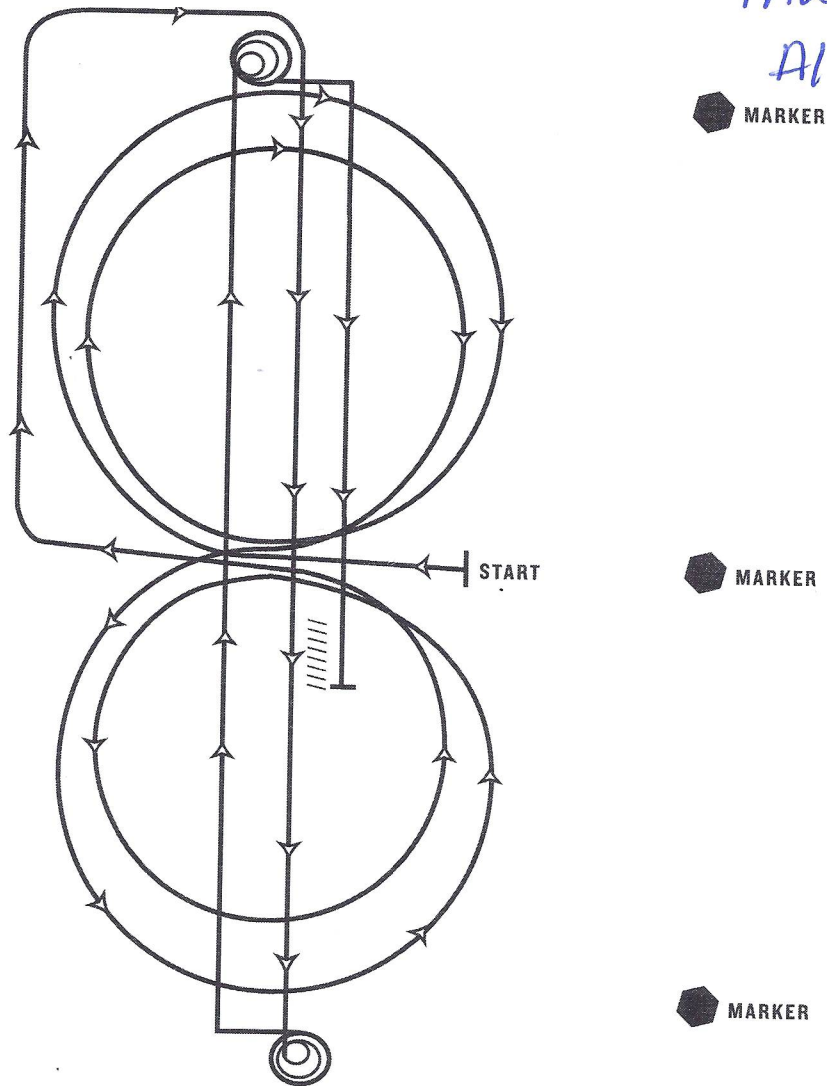

Trot to center of arena, stop. Start pattern facing toward judge.

1. Beginning on the right lead complete 2 circles to the right; the first circle large and fast and the second small and slow. Change leads at the center of the arena.
2. Complete 2 circles to the left, the first circle large and fast and the second small and slow. Change leads at the center of the arena.
3. Continue around end of arena without breaking gait or changing leads, run down center of arena past end marker, and execute a square sliding stop.
4. Complete 3 1/2 spins to the left.
5. Run down center of arena past end marker, and execute a square sliding stop.
6. Complete 3 1/2 spins to the right.
7. Run down center of arena past center marker, and execute a square sliding stop. Back up at least 10 feet. Hesitate to complete pattern.

Pattern 12

- | | |
|------------------|----------------------|
| 1. Right circles | 4. 3 1/2 left spins |
| 2. Left circles | 5. Stop |
| 3. Stop | 6. 3 1/2 right spins |
| | 7. Stop and back up |

This pattern may be used as a lope-in pattern; refer to SHW505.2.

Small Fry - Ranch Riding

Thursday

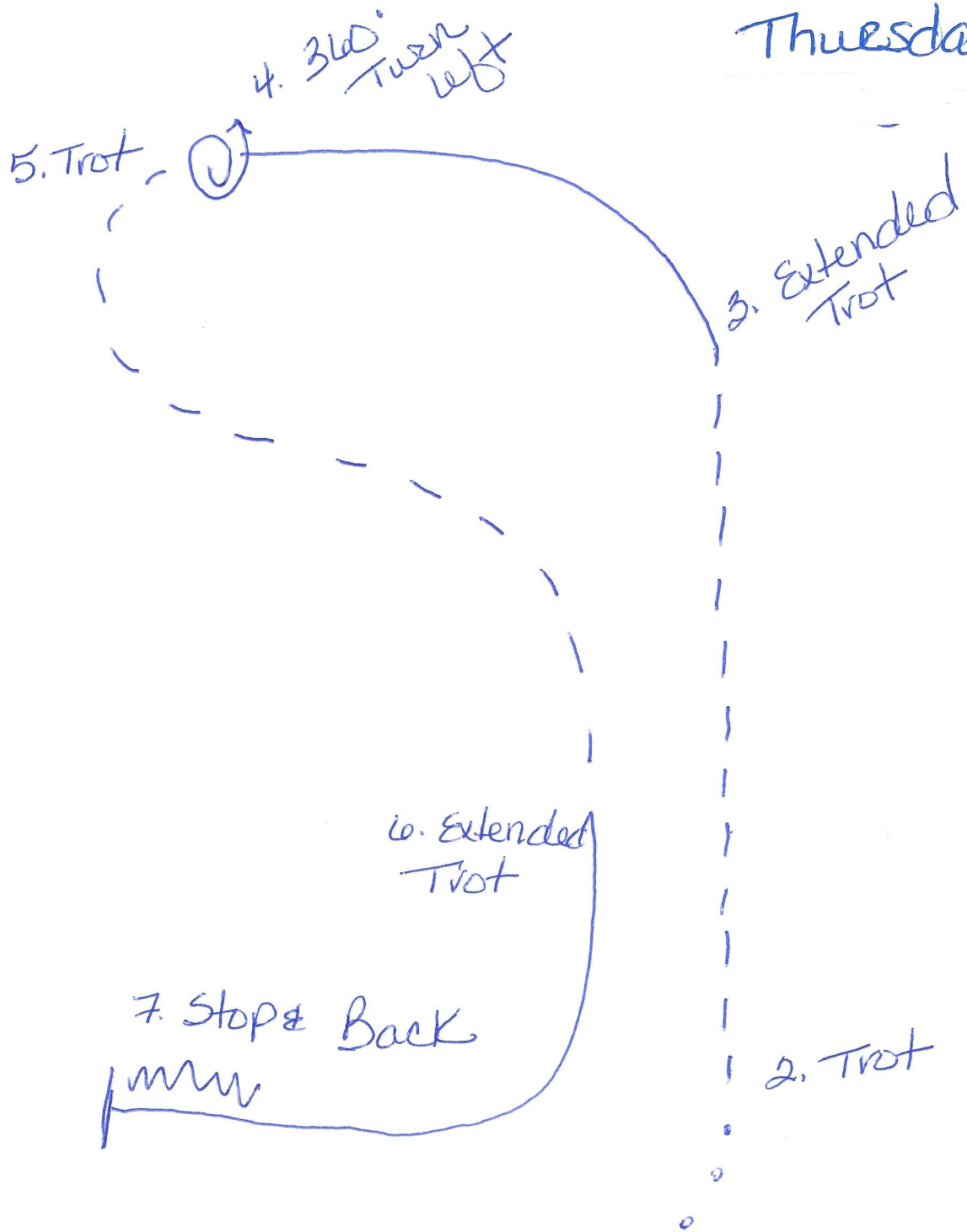

1. Walk
2. Trot

3. Extended Trot
4. 360° Turn left
5. Trot

Start ① walk

6. Extended Trot
7. Stop & Back

RANCH RIDING - PATTERN I

Thursday

All Breed 19#↑
 All Breed 18#↓
 All Rookie classes
 All level 1
 &
 NOVICE
 classes

LEGEND	
.....	Walk
....	Extended Walk
- - -	Trot
- - - -	Extended Trot
—	Lope
— — —	Extended Lope
////	Back
//	Lead Change

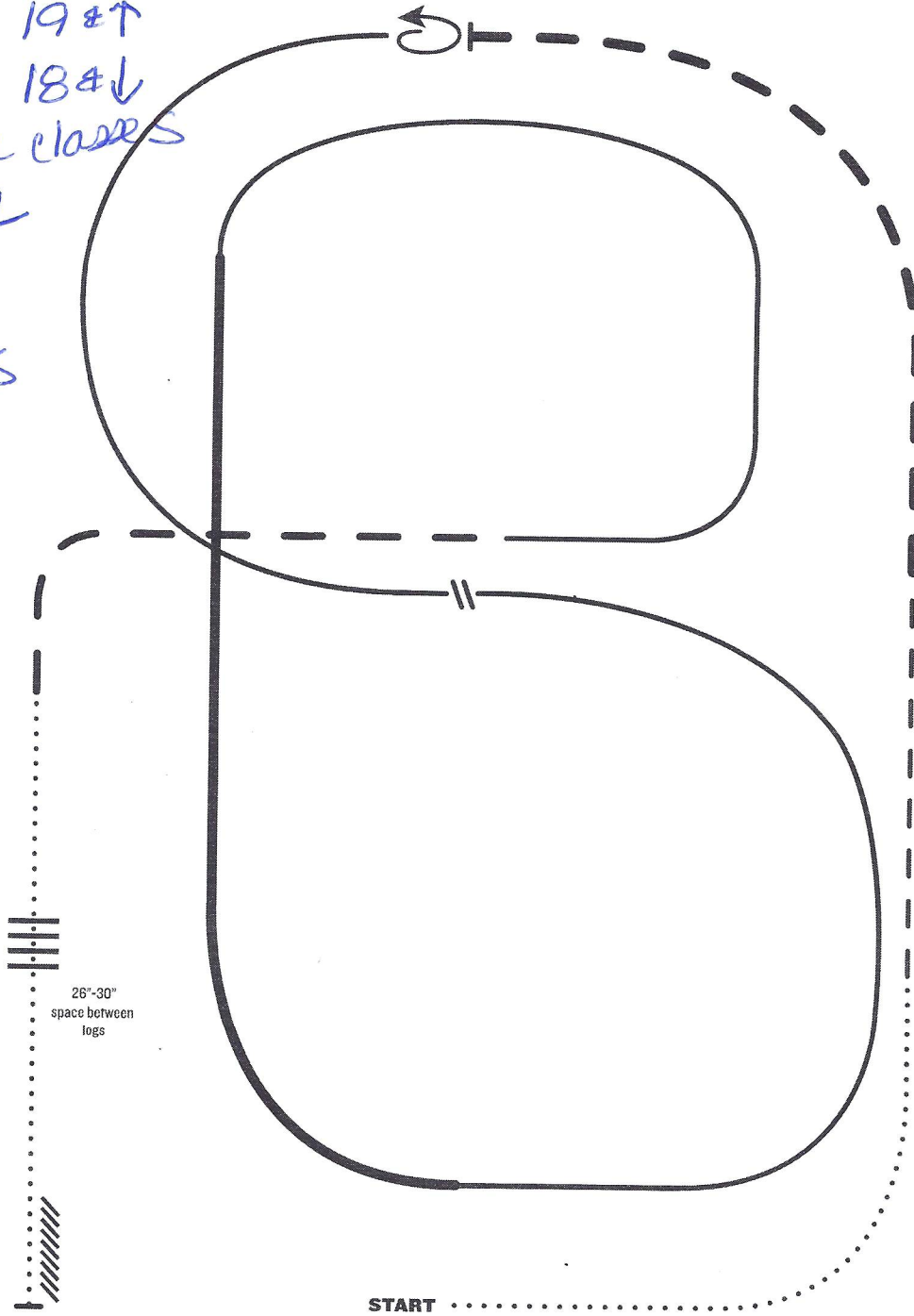

1. Walk
2. Trot
3. Extend the trot, at the top of the arena, stop
4. 360° turn left
5. Left lead 1/2 circle, lope to the center
6. Change leads (simple or flying)
7. Right lead 1/2 circle
8. Extended lope up the long side of the arena (right lead)
9. Collect back to a lope around the top of the arena and back to center
10. Break down to an extended trot
11. Walk over logs
12. Stop and back

Note: The drawn description of this pattern is only intended for the general depiction of the pattern. Exhibitors should utilize the arena space to best exhibit their horses.

RANCH RIDING - PATTERN 5

Thursday

Amateur
Youth
Select
Open
All Breed
Open

OPTIONAL
CATTLE

LEGEND	
.....	Walk
.....	Extended Walk
- - -	Trot
- - -	Extended Trot
— — —	Lope
— — —	Extended Lope
//////	Back
//	Lead Change

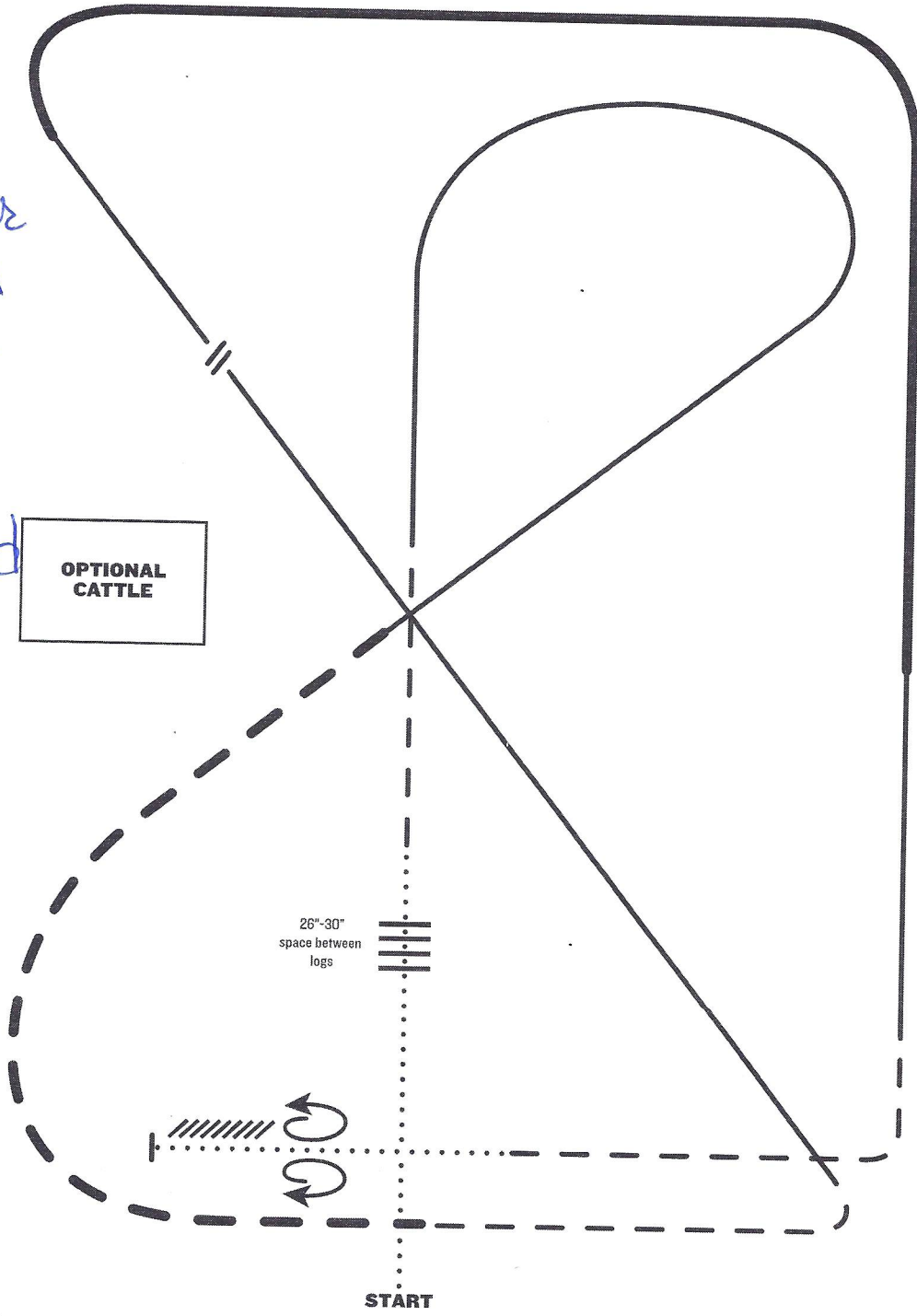

1. Walk
2. Walk over logs
3. Trot
4. Lope right lead
5. Extended trot
6. Trot
7. Lope left lead
8. Change leads (simple or flying)
9. Extended lope right lead
10. Collect lope
11. Trot
12. Walk
13. Stop and back
14. 360° turn each direction (either direction 1st) (L-R or R-L)

Note: The drawn description of this pattern is only intended for the general depiction of the pattern. Exhibitors should utilize the arena space to best exhibit their horses.

OPTIONAL VRH AND RHC RANCH RIDING PATTERN I

Thursday

LEGEND

.....	Walk
.....	Extended Walk
- - -	Trot
- - -	Extended Trot
— — —	Lope
— — —	Extended Lope
//////	Back

All classes

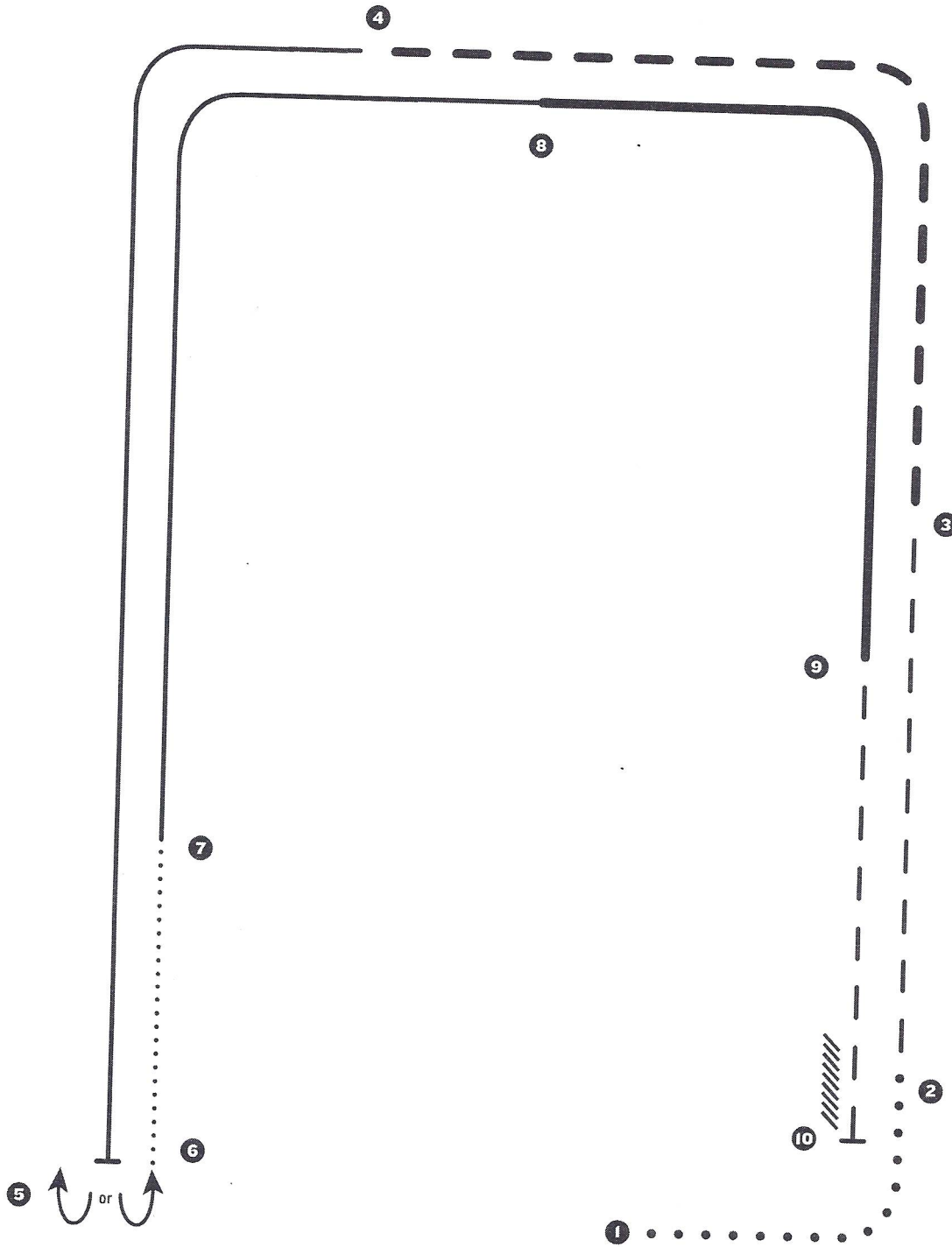

When establishing the course, the following distances are suggested. Patterns may begin in either direction and markers are optional.

1. Extended Walk from 1 to 2 - 75 feet
2. Trot from 2 to 3 - 120 feet
3. Extended Trot from 3 to 4 - 240 feet
4. Lope from 4 to 5 - 150 feet
5. Stop at 5; reverse (either direction)
6. Walk from 6 to 7 - 30 feet
7. Lope from 7 to 8 - 150 feet
8. Extended Lope from 8 to 9 - 200 feet
9. Trot from 9 to 10 - 90 feet
10. Stop and Back at 10 - approximately one horse length

Note: The drawn description of this pattern is only intended for the general depiction of the pattern. Exhibitors should utilize the arena space to best exhibit their horses.

VRH AND RHC RANCH REINING PATTERN 7

Friday
All classes

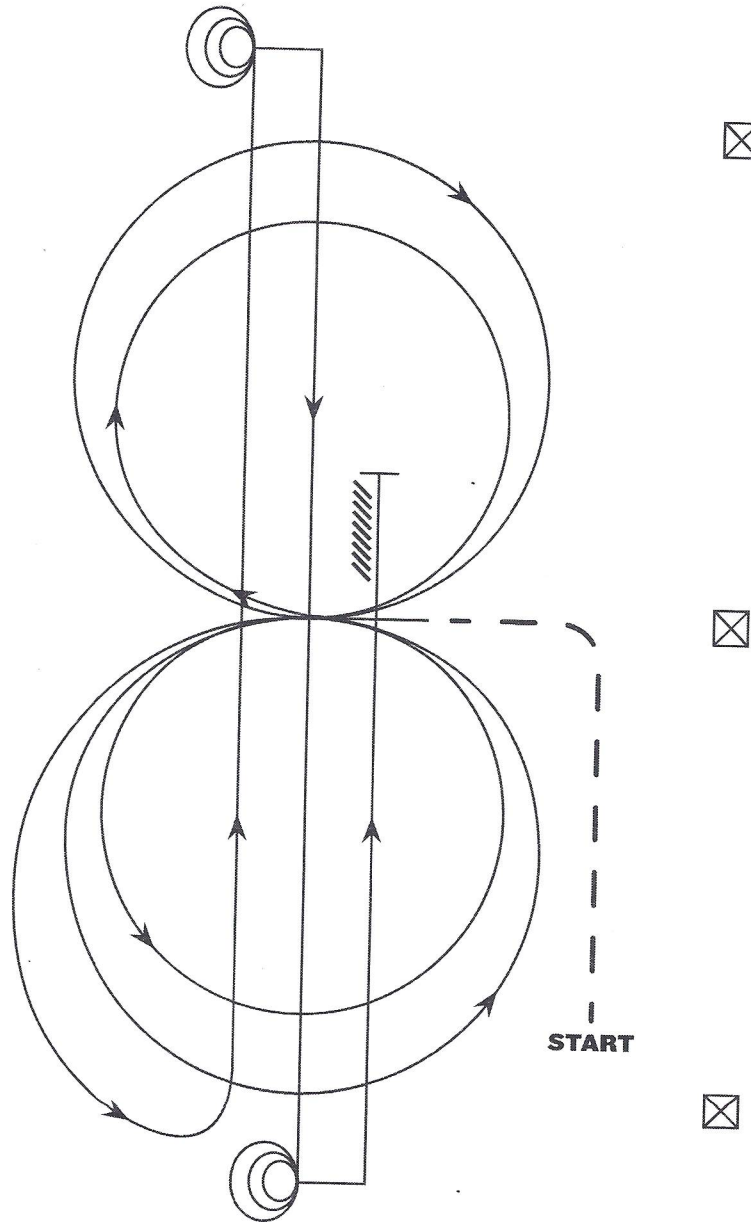

Mandatory Marker along Fence or Wall: The judge shall indicate with markers on arena wall or fence the center of pattern. Judge shall also place markers on fence or wall at least 50' from each end of the arena.

Ride pattern as follows: Trot to center of arena and stop or walk before departure. Start pattern facing toward judge.

1. Beginning on left lead, complete two circles to the left - the first one large and fast, the second one small and slow. Change leads at center of arena.
2. Complete two circles to the right - the first one large and fast, the second one small and slow. Change leads at center of arena.
3. Begin a circle to the left, but do not close this circle. Continuing around the end of arena, run up the center, past end marker, and do a sliding stop.
4. Complete 3 1/2 spins to the left.
5. Run down to other end of arena, past the end marker, and do a sliding stop.
6. Complete 3 1/2 spins to the right.
7. Run past the center marker and do a sliding stop. Back at least 10 feet. Hesitate to show completion pattern

REINING PATTERN 4

Friday

Open
Amateur
Select
☒ Youth
All Breed
Open

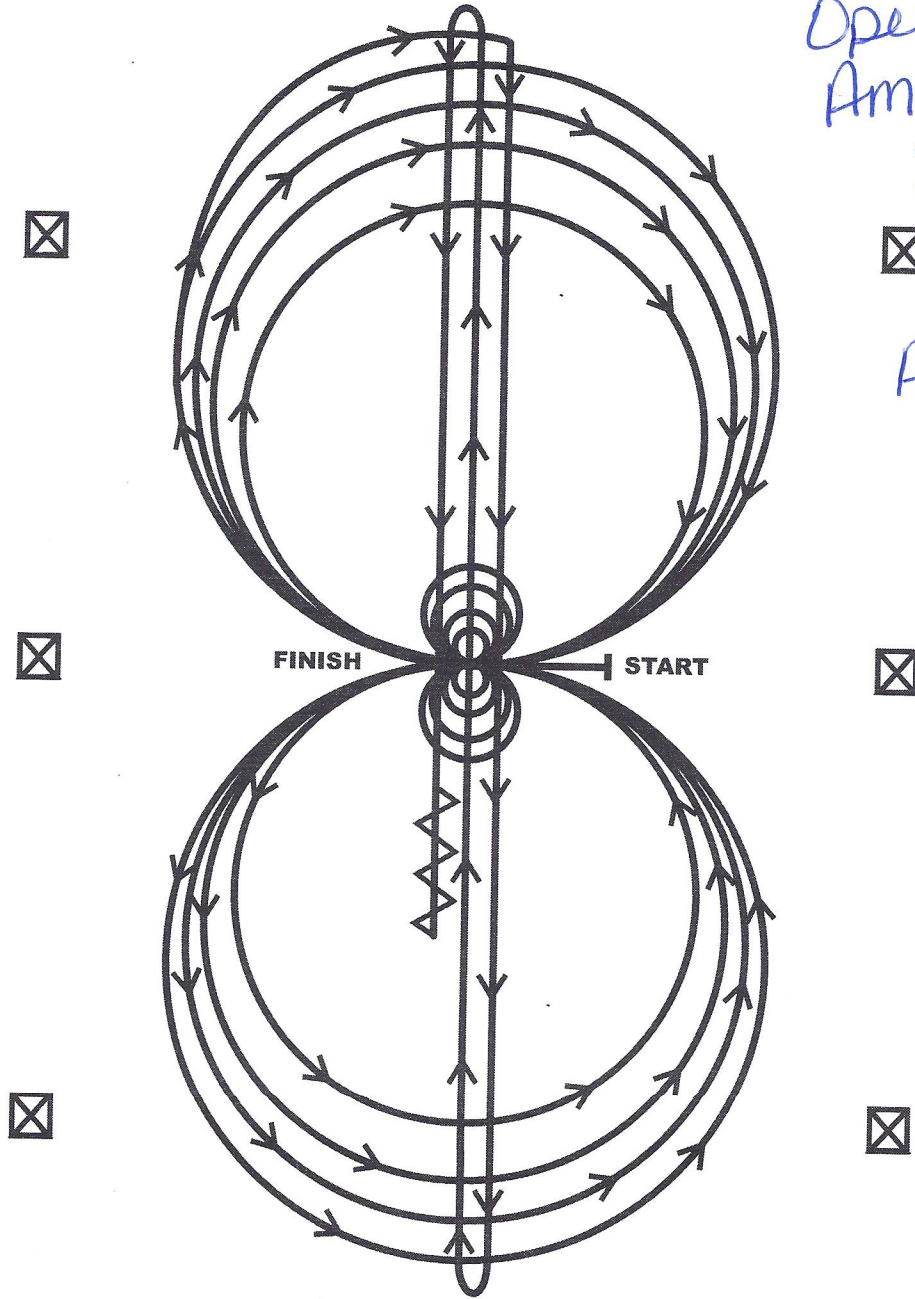

Horses may walk or jog to the center of the arena. Horses must walk or stop prior to starting pattern. Beginning at the center of the arena facing the left wall or fence.

1. Beginning on the right lead, complete three circles to the right: the first two large and fast; the third circle small and slow. Stop at the center of the arena. Hesitate.
2. Complete four spins to the right. Hesitate.
3. Beginning on the left lead, complete three circles to the left: the first two circles large and fast; the third circle small and slow. Stop at the center of the arena. Hesitate.
4. Complete four spins to the left. Hesitate.
5. Beginning on the right lead, run a large fast circle to the right, change leads at the center of the arena, run a large fast circle to the left, and change leads at the center of the arena. (Figure 8)
6. Continue around previous circle to the right. At the top of the circle, run down the middle to the far end of the arena past the end marker and do a right rollback—no hesitation.
7. Run up the middle to the opposite end of the arena past the end marker and do a left rollback—no hesitation.
8. Run past the center marker and do a sliding stop. Back up to the center of the arena or at least ten feet (three meters). Hesitate to demonstrate completion of the pattern.

REINING PATTERN 2

Friday

All Breed 19 & ↑
 All Breed 18 & ↓
 All level 1 &

☒ Novice
 Classes

All Rookie
 Classes

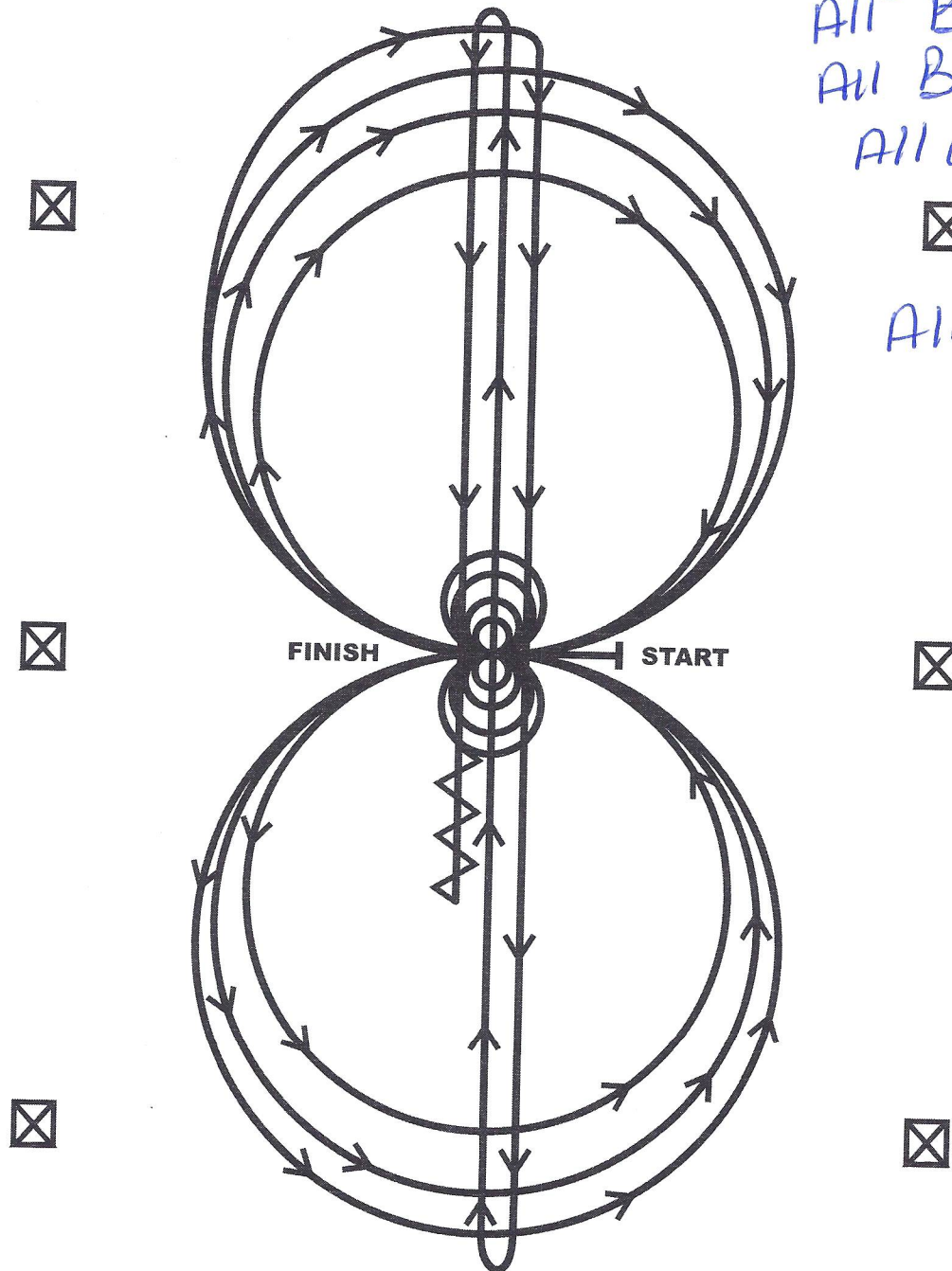

Horses may walk or jog to the center of arena. Horses must walk or stop prior to starting pattern. Beginning at the center of the arena facing the left wall or fence.

1. Beginning on the right lead, complete three circles to the right: the first circle small and slow; the next two circles large and fast. Change leads at the center of the arena.
2. Complete three circles to the left: the first circle small and slow; the next two circles large and fast. Change leads at the center of the arena.
3. Continue around previous circle to the right. At the top of the circle, run down the middle to the far end of the arena past the end marker and do a right rollback—no hesitation.
4. Run up the middle to the opposite end of the arena past the end marker and do a left rollback—no hesitation.
5. Run past the center marker and do a sliding stop. Back up to the center of the arena or at least ten feet (three meters). Hesitate.
6. Complete four spins to the right. Hesitate.
7. Complete four spins to the left. Hesitate to demonstrate the completion of the pattern.

PATTERN 10

LOPE AWAY

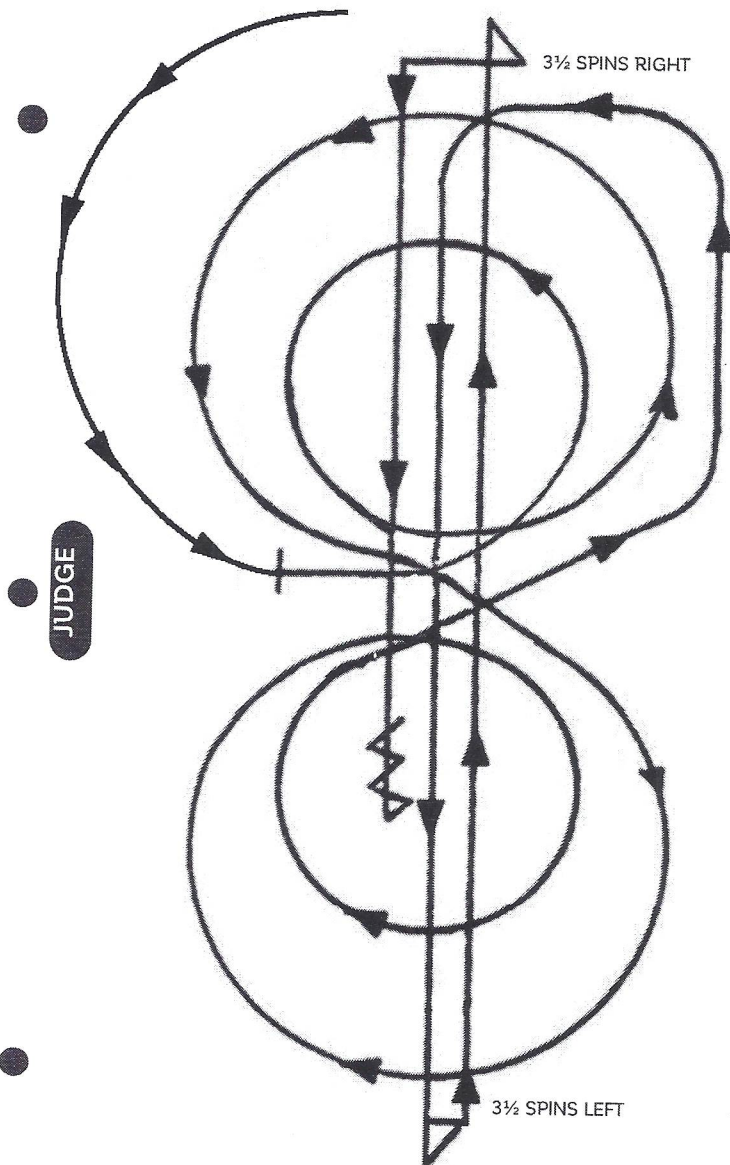

Start on left lead. At the center, without stopping or breaking gait, begin pattern facing away from the judge. Refer to rule 20.6.

1. Beginning on the left lead, complete two circles to the left. The first circle small and slow, the second circle large and fast. Change leads at the center of arena.
2. Complete two circles to the right. The first circle large and fast, the second circle small and slow. Change leads at the center of arena.
3. Continue around end of arena without breaking gait or changing leads, run down center of arena past end marker, and execute a square sliding stop.
4. Complete 3 1/2 spins to the left.
5. Run down center of arena past end marker, and execute a square sliding stop.
6. Complete 3 1/2 spins to the right.
7. Run down center of arena past center marker, and execute a square sliding stop. Back up at least 10 feet. Hesitate to complete pattern.

Ranch Riding - Small Fry

Saturday

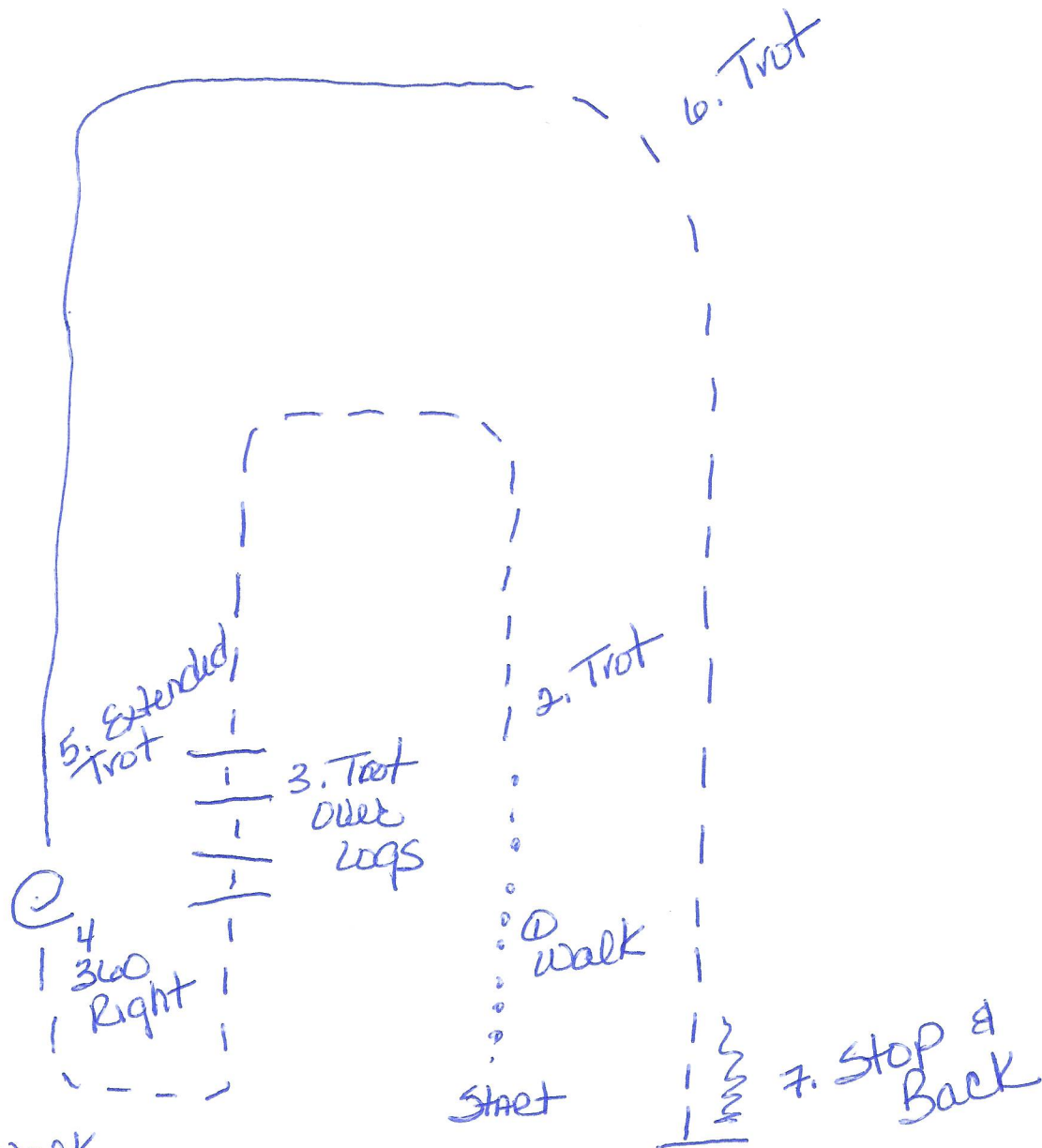

1. walk
2. Trot
3. Trot over logs
4. 360° Turn Right
5. Extended Trot

6. Trot
7. Stop & Back

RANCH RIDING - PATTERN 12

Saturday

LEGEND

.....	Walk
....	Extended Walk
- - -	Trot
- - - -	Extended Trot
— — —	Lope
— — — —	Extended Lope
////	Back
\\	Lead Change

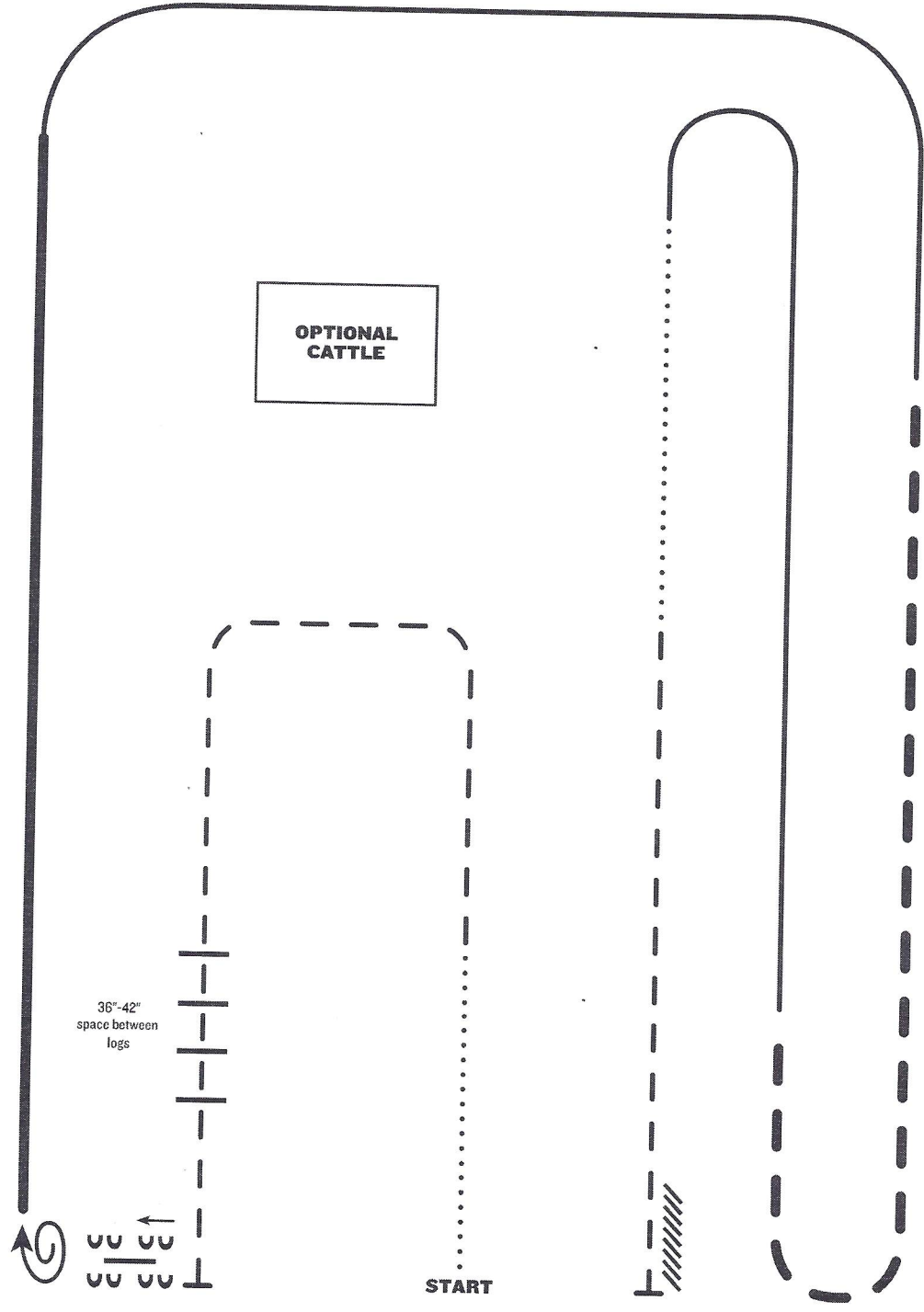

*All Breed 19 ↑
 All Breed 18 ↓
 All Rookie
 Beginning
 All Level I
 &
 Novice
 Classes*

1. Walk
2. Trot
3. Trot over logs, stop
4. Side pass right over log
5. 1/2 turn right
6. Extended lope right lead
7. Lope right lead
8. Extended trot
9. Lope left lead
10. Walk
11. Trot
12. Stop and back

Note: The drawn description of this pattern is only intended for the general depiction of the pattern. Exhibitors should utilize the arena space to best exhibit their horses.

RANCH RIDING - PATTERN 8

Saturday

LEGEND

.....	Walk
....	Extended Walk
- - -	Trot
- - - -	Extended Trot
—	Lope
— — —	Extended Lope
////	Back
	Lead Change

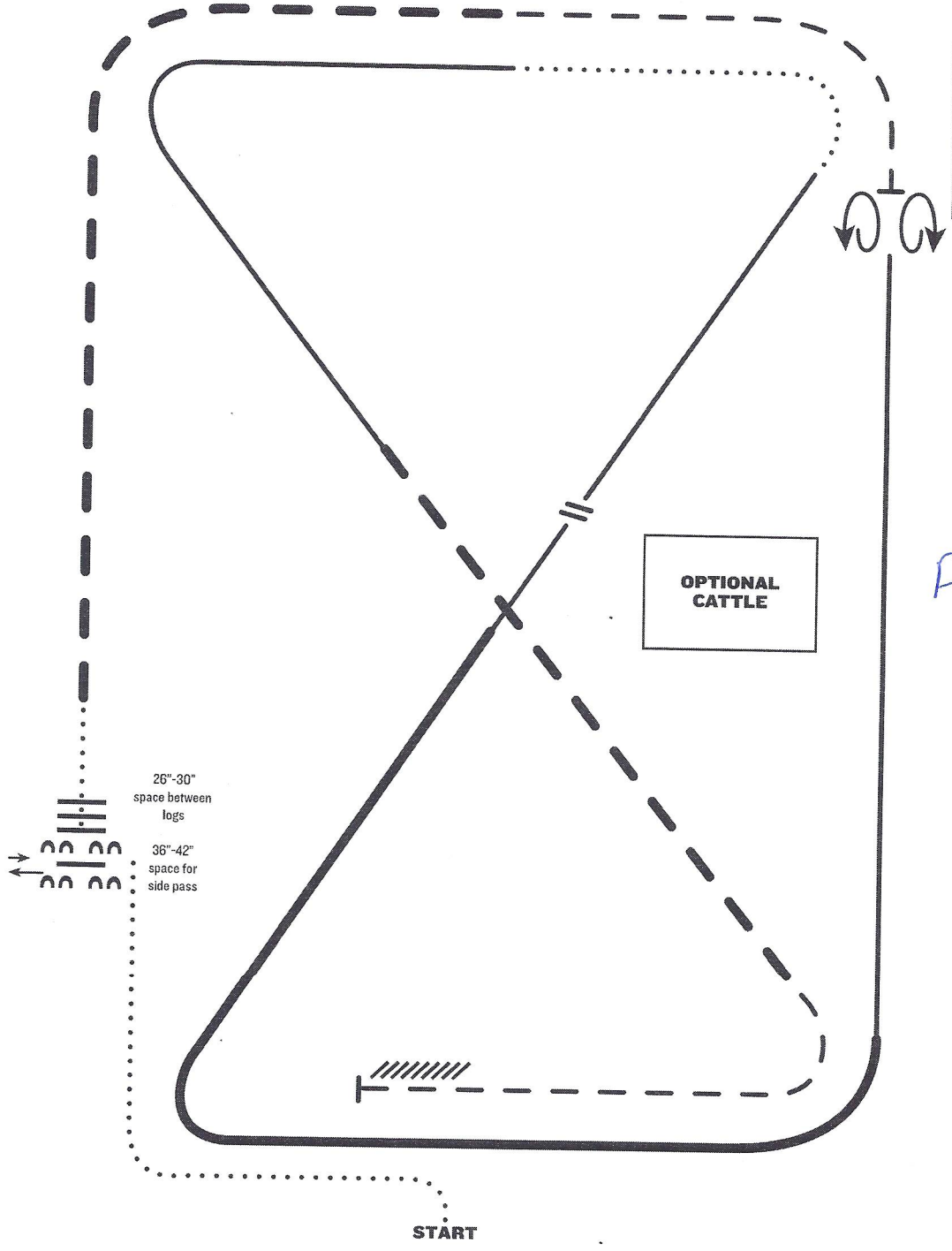

Amateur
youth
Select
Open
All Breed
Open

1. Walk
2. Side pass left across first log, side pass 1/2 way to right
3. Walk over logs
4. Extended trot
5. Trot
6. Stop, 360° turn each direction (either direction 1st) (L-R or R-L)
7. Lope right lead
8. Extended lope right lead
9. Collect lope, change leads (simple or flying), continue lope left lead
10. Walk
11. Lope left lead
12. Extended trot
13. Trot
14. Stop and back

Note: The drawn description of this pattern is only intended for the general depiction of the pattern. Exhibitors should utilize the arena space to best exhibit their horses.

Saturday

OPTIONAL VRH AND RHC RANCH RIDING PATTERN 2

LEGEND

.....	Walk
.....	Extended Walk
- - -	Trot
- - -	Extended Trot
— — —	Lope
— — —	Extended Lope
//////	Back

All Classes

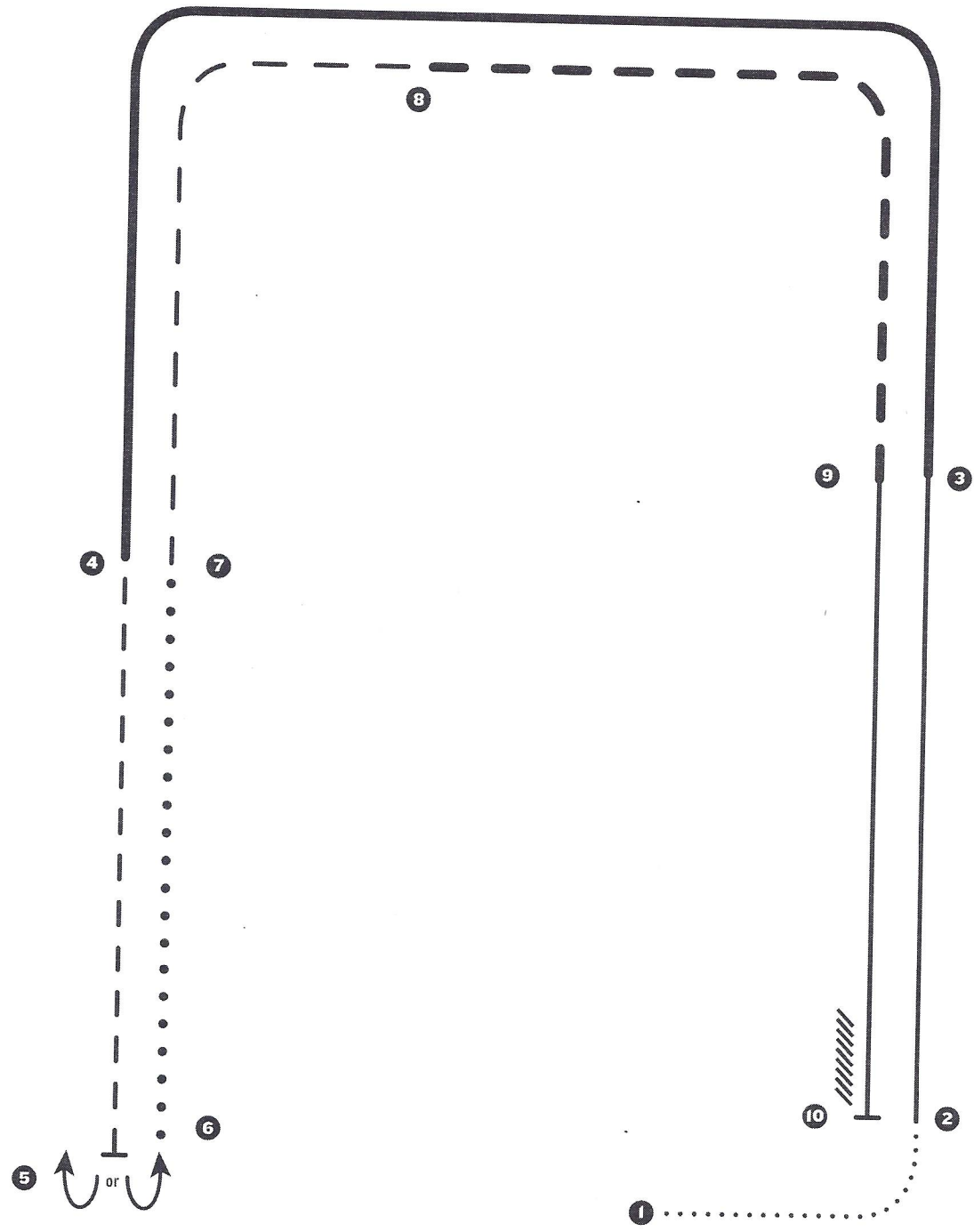

When establishing the course, the following distances are suggested. Patterns may begin in either direction and markers are optional.

1. Walk from 1 to 2 - 30 feet
2. Lope from 2 to 3 - 150 feet
3. Extended Lope from 3 to 4 - 200 feet
4. Trot from 4 to 5 - 120 feet
5. Stop at 5; reverse (either direction)
6. Extended Walk from 6 to 7 - 75 feet
7. Trot from 7 to 8 - 90 feet
8. Extended Trot from 8 to 9 - 240 feet
9. Lope from 9 to 10 - 150 feet
10. Stop and Back at 10 - approximately one horse length

Note: The drawn description of this pattern is only intended for the general depiction of the pattern. Exhibitors should utilize the arena space to best exhibit their horses.

VRH AND RHC RANCH REINING PATTERN 3

Sunday
All classes

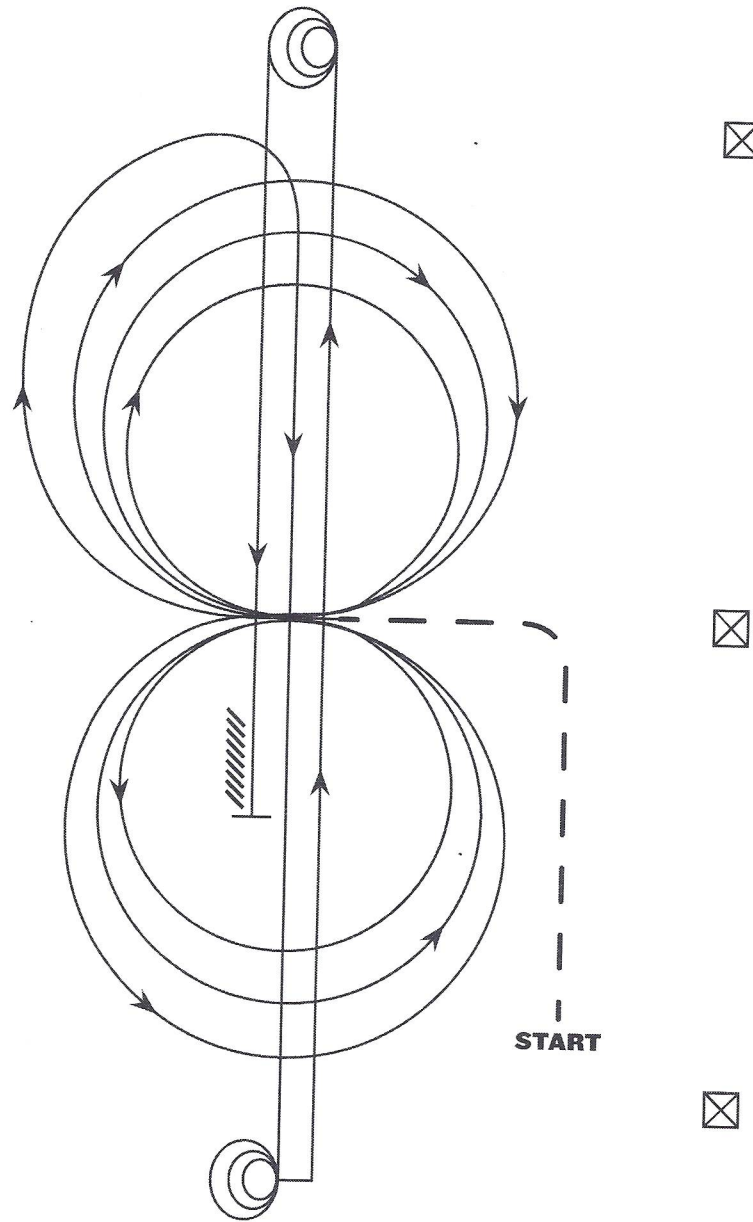

Mandatory Marker along Fence or Wall: The judge shall indicate with markers on arena fence or wall the center of pattern. Judge shall also place markers on fence or wall at least 50' from each end of the arena.

Ride pattern as follows: Trot to center of arena and stop or walk before departure. Start pattern facing toward judge.

1. Beginning on right lead, complete three circles to the right - the first two large and fast; the third one small and slow. Change leads at center of arena.
2. Complete three circles to the left - the first two large and fast; the third one small and slow. Change leads at center of arena.
3. Begin a large circle to the right, but do not close this circle. Run down center of arena, past the end marker, and do a sliding stop.
4. Complete 3 1/2 spins to the right.
5. Run up center of arena to the opposite end, past the end marker, do a sliding stop.
6. Complete 3 1/2 spins to the left.
7. Run back to the middle of the arena, past the center marker, and do a sliding stop. Back up at least 10 feet. Hesitate to show completion of pattern.

REINING PATTERN 16

Sunday

*Open
Amateur*

☒ *Select
youth*

*All Breed
Open*

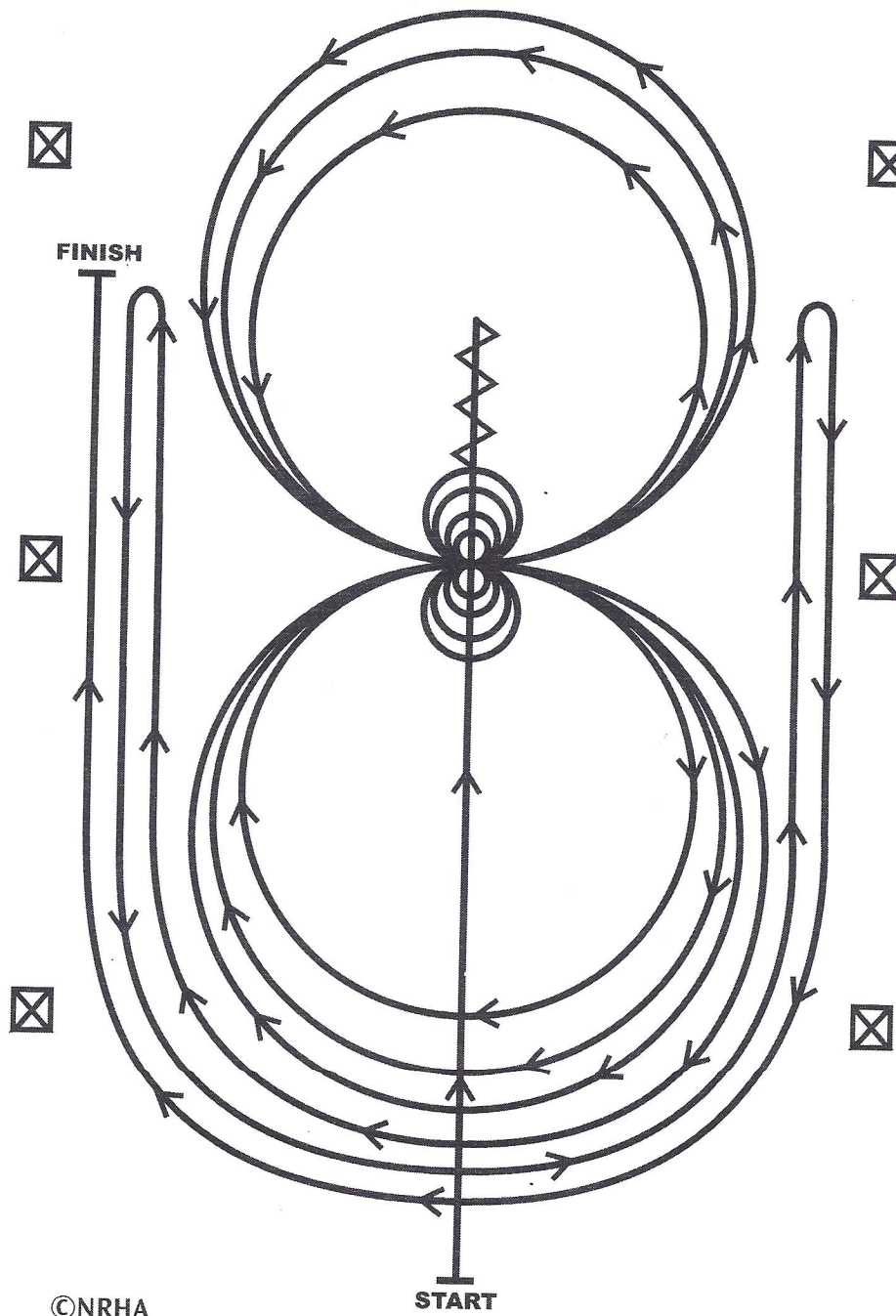

1. Run past the center marker and do a sliding stop. Back up to the center of the arena or at least 10 feet (3 meters). Hesitate.
2. Complete four spins to the left. Hesitate.
3. Complete four and one-quarter spins to the right so that the horse is facing the right wall or fence. Hesitate.
4. Beginning on the right lead, complete three circles to the right: the first two circles large and fast; the third circle small and slow. Change leads at the center of the arena.
5. Complete three circles to the left: the first two circles large and fast; the third circle small and slow. Change leads at the center for the arena.
6. Begin a large circle to the right but do not close this circle. Run up the left side of the arena past the center marker and do a left rollback at least 20 feet (6 meters) from the wall or fence-no hesitation.
7. Continue back around previous circle but do not close this circle. Run up the right side of the arena and past the center marker and do a right rollback at least 20 feet (6 meters) from the wall or fence-no hesitation.
8. Continue back around previous circle but do not close this circle. Run up the left side of the arena past the center marker and do a sliding stop at least 20 feet (6 meters) from the wall or fence. Hesitate to demonstrate completion of pattern.

REINING PATTERN 14

Sunday

All Breed 19 & 1
All Breed 18 & 1

All Rookie
Classes

⊠ Beginning

All level 1

&
Novice
Classes

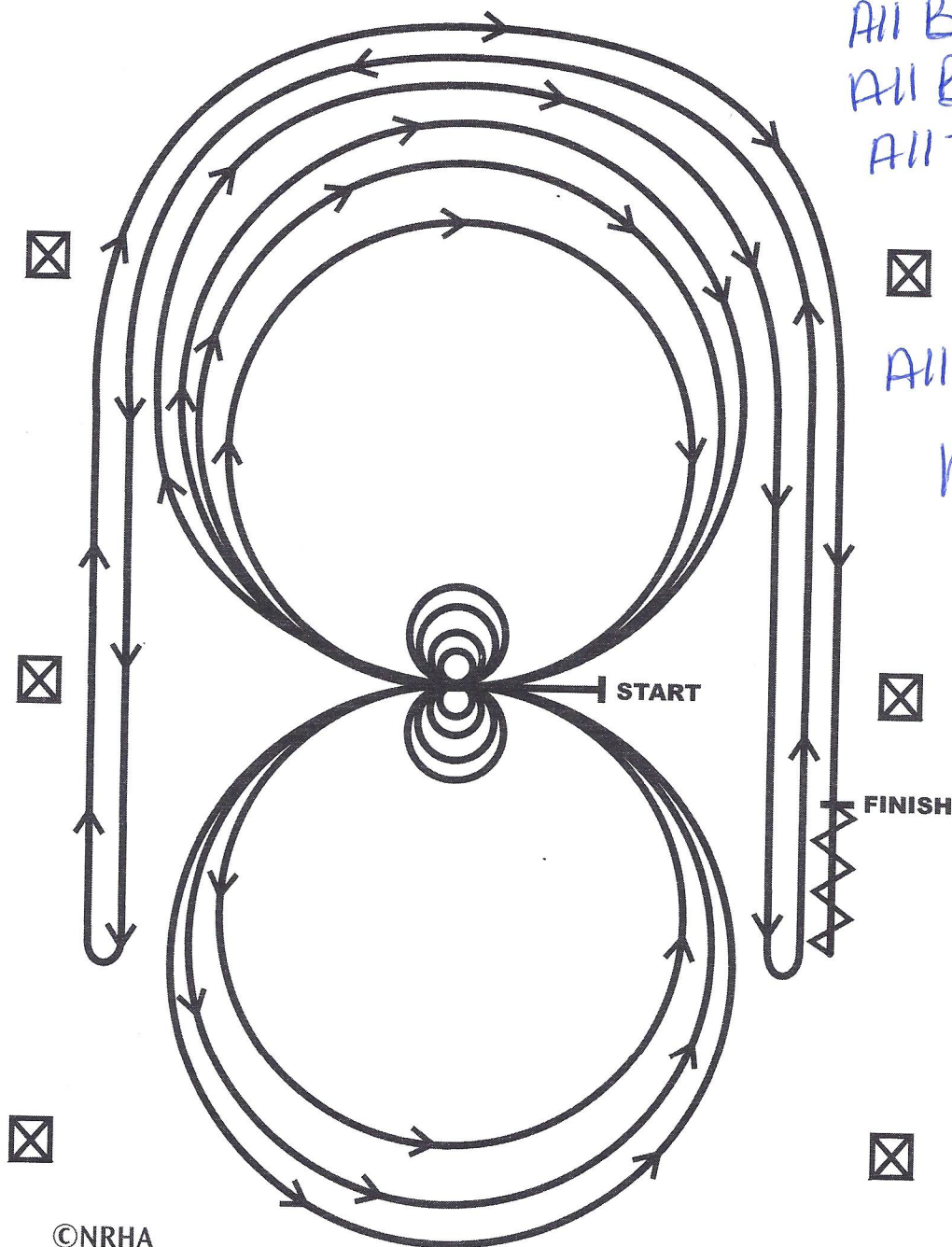

©NRHA

Horses may walk or jog to the center of arena. Horses must walk or stop prior to starting pattern. Beginning at the center of the arena facing the left wall or fence.

1. Complete four spins to the left. Hesitate.
2. Complete four spins to the right. Hesitate.
3. Beginning on the right lead, complete three circles to the right: the first two circles large and fast; the third circle small and slow. Change leads at the center of the arena.
4. Complete three circles to the left: the first two circles large and fast; the third circle small and slow. Change leads at the center of the arena.
5. Begin a large circle to the right but do not close this circle. Run up the right side of the arena past the center marker and do a left rollback at least twenty feet (six meters) from the wall or fence—no hesitation.
6. Continue back around previous circle but do not close this circle. Run up the left side of the arena past the center marker and do a right rollback at least twenty feet (six meters) from the wall or fence—no hesitation.
7. Continue back around previous circle but do not close this circle. Run up the right side of the arena past the center marker and do a sliding stop at least twenty feet (six meters) from the wall or fence. Back up at least ten feet (three meters). Hesitate to demonstrate the completion of the pattern.